

Article number: 2011301050ST  
 Description: E+G Lifting pins in Steel,  
 GN 1130-10-50-ST

## Measures

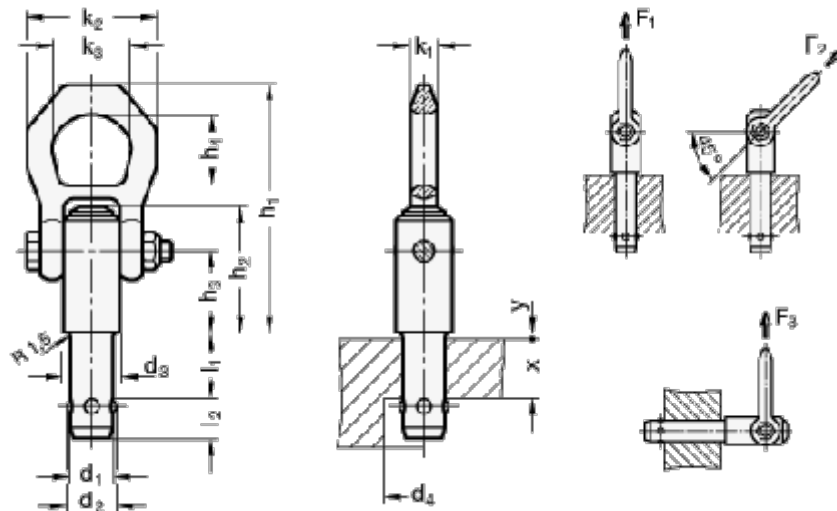

d1	= 10	h4	= 27	y = 1.5
d2	= 11.7	l1	= 50	
d3	= 21.5	l2	= 10.199999999999999	
d4	= 12.2	k1	= 11	
F1/F2/F3 load in kN	= 2,7/2,4/2,1	k2	= 49	
h1	= 87.5	k3	= 30	
h2	= 38.5	Weight (g)	= 252	
h3	= 25.7	x	= 40	